

Vacuum Solutions



For the sake of the environment – efficient vacuum generation using diaphragm pumps





Buchi Labortechnik AG has been equipping laboratories all over the world with highly advanced and innovative devices for decades. We are continuously searching for new way of easing our customers' routine laboratory work by providing them with robust, durable, and simple to operate equipment.

Our "Buchi vacuum solutions" are complete solutions for creating vacuum in the laboratory. At the heart of these devices are oil-free diaphragm vacuum pumps that never fail to impress by their high performance and unique technical solutions. Pump control and the various vacuum regulation functions are performed by V-850 or V-855 vacuum controllers. The pump and the wide range of accessories form a complete unit with plug-in equipment connections to make laboratory tasks more efficient and easier.

Diaphragm vacuum pumps address resource conservation and environmental awareness; two issues often associated with the use of water jet pumps, as high water consumption and water polluting solvent vapours are avoided. A good reason for you to choose a practically maintenance-free system that requires no oil changes and operates independently of a centralised vacuum source.

To meet the high economical and ecological standards, the new Eco²-mode has been introduced for the Vacuum Pumps V-700 and V-710. The Eco²-mode is enabled automatically as soon as the pump is used without a vacuum controller and results in a reduction in the energy consumption and the noise emissions. As a consequence not only the running costs are reduced, the safety in the laboratory is also increased.

Solutions from a single source – from Buchi Labortechnik

Vacuum is needed for a wide range of laboratory tasks and is frequently used in combination with a Rotavapor. This perfect match of rotation evaporator, vacuum controller and vacuum pump allows Buchi to offer a polished total solution with optimised interfaces, small footprint, integrated know-how and the highest safety standards.

The modular approach means that individual components can be combined in any way required – a clear advantage in large laboratories or where many different applications are involved. The comprehensive range of accessories allow vacuum pumps to be extended at any time to form a complete vacuum system.

See the advantages of Buchi vacuum solutions for yourself!

Vacuum Pumps V-700 and V-710 – the innovative way to generate a vacuum

Vacuum Pump V-700

The V-700 is a chemical-resistant PTFE diaphragm pump for delivering all types of gases and vapours. With a capacity 1.8 m³/h and a final vacuum of less than 10 mbar it covers a large range of traditional laboratory applications and is optimally designed for use with a rotation evaporator. Further typical applications include the evacuation of drying cabinets or centrifuges and the creation of vacuum for filtration or for delivery of liquids.

This pump features the following advantages:

- Quiet, low-vibration operation due to ingenious sound insulation system, full housing enclosure and weight balance.
- Integrated gas ballast: The constantly high suction volumes also dry the diaphragms during operation.
- The principally axial movement of the PTFE diaphragm increases service life.
- Effective safety features: the pump will only operate when the housing is closed, there is overcurrent protection with reset and an integrated operating hours meter.
- An innovative single stroke control for regulating speed to provide a hysteresis-free and precise vacuum (in combination with vacuum controller V-850/855).
- The new Eco²-mode generates an appropriate vacuum in continuous operation without a vacuum controller. For applications, e.g. involving the evacuation of drying cabinets, desiccators, etc., the suction capacity of the pump is no longer needed once the ultimate



vacuum has been reached. The Eco²-mode reduces the speed of the pump after one hour without restricting the application. This action provides active protection for the environment due to low solvent and noise emissions and the low energy consumption.



red dot design award



Light, compact design with small footprint and robust design with integrated carrying handle.

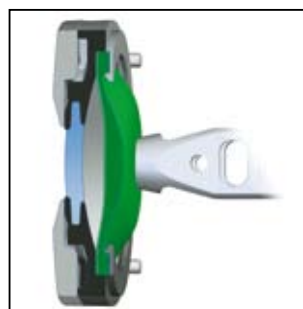

The unique glass/PEEK head reveals the diaphragm and allows easy inspection of the evaporation conditions and visual detection of any contaminants.



Oil-free, practically maintenance-free, with removable upper housing and integrated spanner to allow easy access to the diaphragms.



Active protection for the environment – if the pump is operated without a vacuum controller or vacuum module, the speed is reduced to 80% after 1 hour of continuous operation and to 50% after 2 hours without changing the vacuum.

Vacuum Pump V-710

The V-710 is the larger version and has four diaphragm heads. The three-stage vacuum creation process delivers an impressive 3.1 m³/h at a low final pressure of less than 2 mbar. The pump can be used anywhere high suction capacity or low final vacuum is required. The full housing enclosure makes the pump universally applicable either on the

laboratory bench or for integration into laboratory furniture.

For usage as a central laboratory vacuum system, we recommend the combination of Vacuum Pump V-710 with Vacuum Module V-802 LabVac for maximum suction performance in continuous operation.



The compact vacuum source for the Rotavapor R-220.



V-700: Graph of suction capacity against pressure

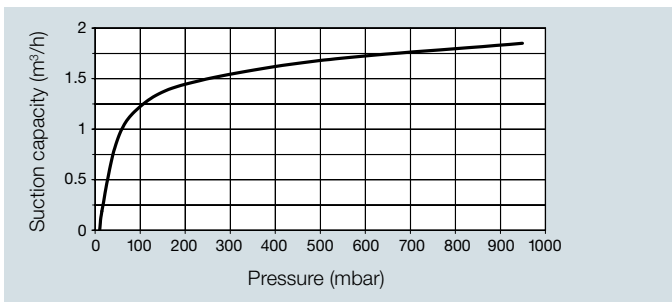

V-710: Graph of suction capacity against pressure

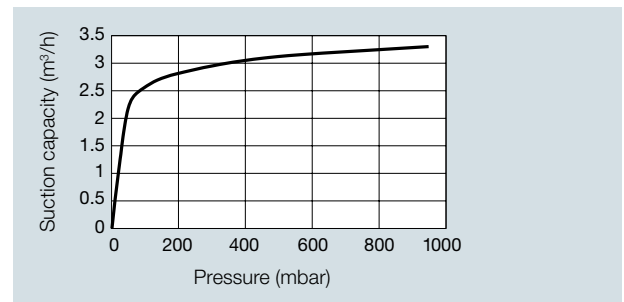

V-700: Evacuation time for a Rotavapor R-210/215

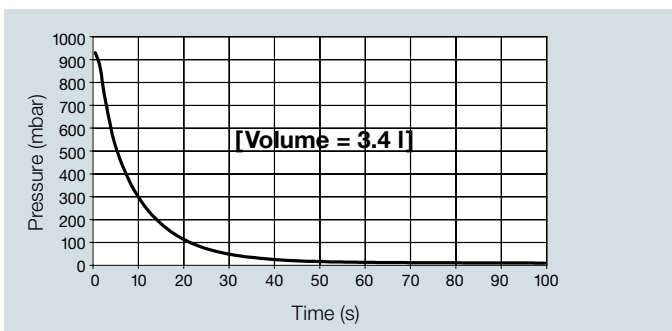

V-710: Evacuation time for a Rotavapor R-220

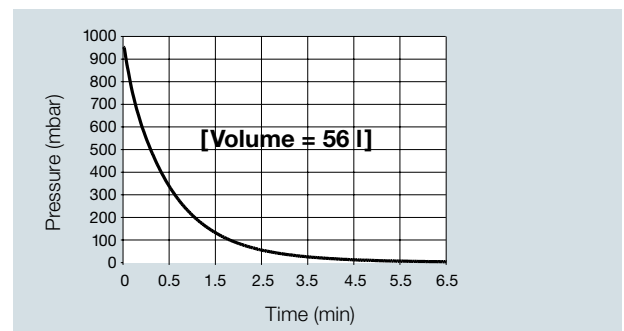

Vacuum Controllers V-850 and V-855 – the smart way to regulate a vacuum

To make the most of the huge potential of the vacuum pumps they should be used with the Vacuum Controller V-850 or V-855. The intuitive operating concept is suitable for a wide range of applications and, from the simple regulation of a vacuum setpoint to the automatic distillation of complete mixtures, will cover all your needs.

The vacuum controllers are the result of close collaboration with customers during development to adapt the controllers even more precisely to the needs of day-to-day work in the laboratory. Only a defined, regulated vacuum will provide con-

trolled conditions for a quick, reliable evaporation process. Specific aspects are significantly lower solvent emissions, fewer boiling delays and less foaming, as well as reproducible process conditions.

You can profit from these advantages with the Vacuum Controllers V-850/855 and increase your effectiveness and efficiency in the laboratory.

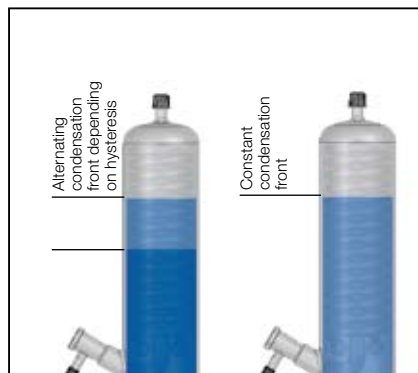

Reliable and simple to use

The consistent use of inert materials such as ceramic and PEEK at the pressure sensor ensures the highest resistance to aggressive chemicals. If the power supply is interrupted, the integrated ventilation valve opens so that the product does not become overheated. The specified pressure is quickly set by means of a rotary knob, other parameters by just a few button presses. All necessary information is clearly visible whenever required on a bright and uncluttered graphical display – and is available in various languages.

Speed regulation using the V-700/710's single stroke control

A newly developed single stroke control in the V-700/710 pump regulates the speed and ensures that a hysteresis-free vacuum is created. The precise pressure curve produces a constant condensation front and ensures maximum evaporation performance. This type of regulation by vacuum controllers V-850/855 leads to whisper-quiet operation. There is no need for an additional vacuum valve.

Compatibility with pump and Rotavapor

The V-850/855 generation of controllers is ideally suitable for the Rotavapor and V-700/710 vacuum pumps. The integrated RS-485 interface automatically recognises the connected devices and provides full communication. Full compatibility with previous models is also guaranteed. The power comes directly from the pump or the Rotavapor – a separate mains cable is not required. If the vacuum controller is used as a stand-alone device it will require a mains adapter.



Vacuum Controller V-850

The V-850 is designed for standard applications with the following functions:

- Vacuum regulation of set pressure – with V-700/710 pump by speed regulation or by the switching on and off of a vacuum valve.
- Timer function for stopping the process after a preset time.

- LabVac function: intelligent control of the pump in a laboratory system with several consumers (see page 9).
- Buchi wizard for a quick configuration using simple menu control.
- USB interface for data transfer to PC for storage, evaluation and optimization

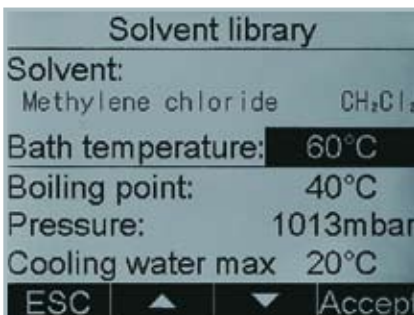

- The solvent library, an integrated library with 43 preset solvents that can be expanded by the customer considerably simplifies parameter selection. After the selection of the solvent used, the related parameters for optimal distillation are entered as default values depending the bath temperature!

Other solvent data can be conveniently downloaded from the Buchi home-page (www.buchi.com).

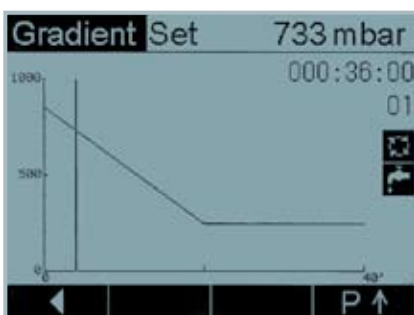

Vacuum Controller V-855

The V-855 is the top model and offers additional features compared to the V-850:

- Programming function for pressure gradients for special distillation tasks: It is able to store up to 15 processes with programmable gradients. Ideal for difficult to distil products like foaming extracts or those with boiling delay.

- Automatic distillation with a stage probe positioned in the rotary evaporator's condenser. The probe detects the condensation level and automatically adjusts the pressure. The stage probe is suitable for foaming substances or for maximum solvent recovery.

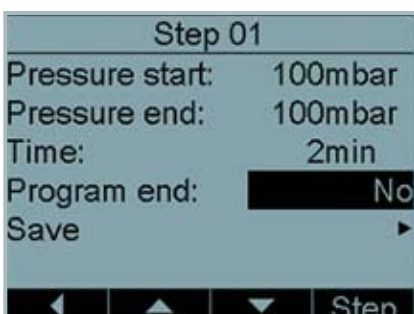

- EasyVac function: automatic process control based on vapour pressure detection (see page 8) – it couldn't be easier!

The EasyVac function guarantees the simplified, automatic distillation of individual solvents and complex solvent mixtures, whenever time is the issue during distillation.

- Repeat function: The pressure curve of a manual or automatic distillation can be stored and retrieved anytime as setpoint values for optimum process conditions.

EasyVac – the easy way to perform automatic distillation

In combination with the Vacuum Module V-801 EasyVac, the Vacuum Pump V-700 becomes a unique distillation system for the automatic evaporation of individual solvents or complex solvent mixtures. EasyVac automatically finds the start point and optimally regulates the pressure until the distillation process is complete.

Vacuum Module V-801 EasyVac – the gentle evaporation



The vacuum module EasyVac for the Vacuum Pump V-700 and V-710 is a new concept for vacuum regulation during the distillation of individual solvents and solvent mixtures until dry. The process is started with the press of a button and automatically finds the starting point for the distillation, regulates the pressure to suit the vapour pressure curve and can determine the end point for a distillation. Based on refined algorithms and pressure changes over time, the process is robust and gentle on the product. This method provides fast, gentle evaporation during distillation. With the EasyVac you are opting for exactly the right control unit for a fast, automatic evaporator system

with maximum cooler utilisation – delegate your process settings and obtain the highest distillation rates.

Order no. 47252

Distillation rates during automatic distillation

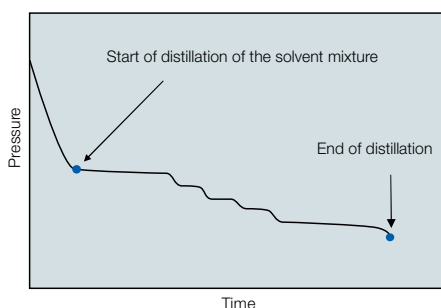

Pressure course during automatic distillation

Rotavapor: bath temperature 45 °C, cooling water temperature 5 °C

Solvent	Volume	Distillation time until dry
Petroleum ether	350 ml	Approx. 4.5 min.
Ethyl acetate	350 ml	Approx. 5.5 min.
Dichloromethane	350 ml	Approx. 5 min.
Acetone/ethyl acetate/THF	350 ml	Approx. 7 min.
Acetone/ethyl acetate	350 ml	Approx. 7.5 min.

Multivapor: rack temperature 53 °C, cooling water temperature 5 °C

Solvent	Volume	Distillation time until dry
Ethyl acetate	12 x 20 ml	Approx. 8 min.
Hexane/ethyl acetate 4:1	12 x 20 ml	Approx. 7 min.
Toluene	12 x 20 ml	Approx. 10 min.

LabVac – the ideal solution for your laboratory vacuum system

Combined with the Vacuum Module V-802 LabVac, the Vacuum Pump V-700/710 forms an efficient, easy to use laboratory vacuum system to which various vacuum consumers can be connected.

Vacuum Module V-802 LabVac

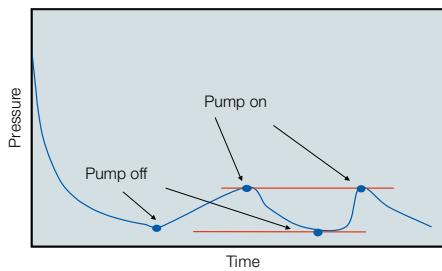

The Vacuum Module V-802 LabVac is a vacuum module that has been specifically developed for a laboratory vacuum system with several consumers. The pump is switched on and off depending on the consumers to provide the required vacuum with minimum energy use. In CONT mode the pump operates continuously to create as low a vacuum as possible irrespective of the consumers connected.

With a wide range of tubing, adapter cables for valves from other manufacturers and connection pieces, the vacuum system can be adapted to different systems including to complete integration into laboratory furniture.

Order no. 47254

A powerful vacuum pump as a central laboratory vacuum system



Vacuum sources – the right choice

1. The basic pump for creating a vacuum



- General vacuum use
- Vacuum Pump V-700

2. The stand-alone system for routine tasks in the laboratory – the direct method of automatic distillation



- Rotation evaporator
- V-700 EasyVac
Vacuum Pump V-700
Vacuum Module V-801 EasyVac
Woulff bottle

3. The standard system is a flexible, compact unit with many uses



- Rotation evaporator
- V-700 Advanced
Vacuum Pump V-700
Vacuum Controller V-850
Woulff bottle

4. The efficient system for the 20 L standard



- Large rotation evaporator
- Vacuum Pump V-710
- Vacuum Controller V-850 for R-220

5. The compact solution for parallel evaporation and synthesis

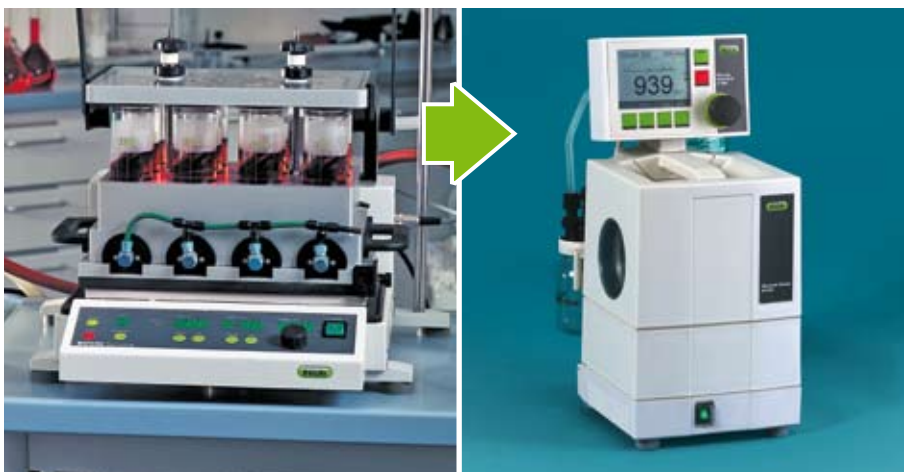

- Syncore
- V-700 Professional Vacuum Pump V-700
- Vacuum Controller V-855
- Woulff bottle
- Secondary condenser

6. Extension to serve several stations in the laboratory – ideal for providing all the vacuum required



- Several different consumers
- V-710 LabVac Vacuum Pump V-710
- Vacuum Module V-802 LabVac
- Woulff bottle

Combinations of Rotavapor – vacuum systems

Selection matrix for communication cable RJ45/mini-DIN, Woulff bottle and valve unit

Rotavapor					
	R-210/215 without V-850/855	R-210/215 with V-850/855	More than one R-210/215 with V-850/855	On the Rotavapor, old generation (without controller)	
Vacuum system	V-700/710	* Combination not recommended, as vacuum regulation not possible	<ul style="list-style-type: none"> Communication cable RJ45 Order no. 44989 Woulff bottle Order no. 47170 	Per R-210/215 each: <ul style="list-style-type: none"> One communication cable Mini-DIN Order no. 38010 One valve unit Order no. 47160 	<ul style="list-style-type: none"> Vacuum Controller V-850/855 Woulff bottle Order no. 47170 Communication cable RJ45 Order no. 44989
	V-700/710 Manual vacuum regulation with e.g. needle valve	<ul style="list-style-type: none"> Woulff bottle Order no. 47170 No communication with R-210/215 possible 	* Combination not recommended	* Combination not recommended	<ul style="list-style-type: none"> Woulff bottle Order no. 47170
	V-700/710 with V-850/855	<ul style="list-style-type: none"> Communication cable RJ45 Order no. 44989 Woulff bottle Order no. 47170 	<ul style="list-style-type: none"> Per R-210/215 one valve unit Order no. 47160 	LabVac function <ul style="list-style-type: none"> Valve unit Order no. 47160 	<ul style="list-style-type: none"> Woulff bottle Order no. 47170
	V-700/710 EasyVac	<ul style="list-style-type: none"> Woulff bottle Order no. 47170 	* Combination not recommended	* Combination not recommended	<ul style="list-style-type: none"> Woulff bottle Order no. 47170
	V-700/710 LabVac	* Combination not recommended	<ul style="list-style-type: none"> Valve unit Order no. 47160 	<ul style="list-style-type: none"> Per R-210/215 one valve unit Order no. 47160 	* Combination not recommended
	V-500/V-1000	* Combination not recommended	<ul style="list-style-type: none"> Communication cable Mini-DIN Order no. 38010 Valve unit Order no. 47160 	Per R-210/215 each: <ul style="list-style-type: none"> One communication cable Mini-DIN Order no. 38010 One valve unit Order no. 47160 	<ul style="list-style-type: none"> Vacuum Controller V-850/855 Communication cable Mini-DIN Order no. 38010 Valve unit Order no. 47160
	Other vacuum source (in-house vacuum system, other pumps...)	<ul style="list-style-type: none"> No communication with R-210/215 possible 	<ul style="list-style-type: none"> Valve unit Order no. 47160 	<ul style="list-style-type: none"> Per R-210/215 one valve unit Order no. 47160 	<ul style="list-style-type: none"> Vacuum Controller V-850/855 Valve unit Order no. 47160

* Combination not possible or pointless combination

Rotavapor:

Key to Rotavapor order number

23□□□□□□□□

Valve unit

- 0 Without valve
- 1 Woulff bottle for vacuum controller (for stand-alone system with V-700)
- 2 Valve unit for vacuum controller (not necessary in stand-alone system with V-700)

Valve unit:

Key to vacuum system order number

07□□□□

Woulff bottle

- 0 Without Woulff bottle
- 1 With Woulff bottle (recommended for vacuum systems with controller/module)



Secondary condenser for V-700/710

The secondary condenser is a compact high performance condenser for producing maximum condensation of residual solvent vapour after the pump. At the same time it separates any liquid from the pump directly into the receiving flask. Insulation sleeves prevent the formation of undesirable condensation water and provide the condenser with effective protection against mechanical damage.

Order no. 47180



Secondary cold trap for V-700/710

If dry ice is used instead of cooling water, the secondary cold trap can be used.

Order no. 47190

Valve unit for vacuum controller



Valve combined with condensate trap and non-return valve with attachment for Rotavapor (not necessary with V-700/710 in stand-alone system).

Order no. 47160

Woulff bottle



For trapping particles and droplets and for pressure equalisation (recommended in stand-alone system with V-700/710).

Order no. 47170

Vacuum valve for vacuum controller



For use with a centralised vacuum source or an uncontrolled pump.

Order no. 31353

Vacuum valve for R-220 for vacuum controller



Vacuum valve for Rotavapor R-220. Hose connections 12 mm, including bracket.

Order no. 31354

Vacuum valve for R-250 for vacuum controller



Vacuum valve for Rotavapor R-250. Hose connection 18 mm.

Order no. 31355

Remote control RC-81



The remote control can be used to control the vacuum controller and the Rotavapor: rotation, starting/stopping and raising and lowering of the flask.

Order no. 47230

Cooling water valve for vacuum controller



Helps to save water. The vacuum controller opens the cooling water feed only during distillation.

Order no. 31356

Needle valve for vacuum limiting



Vacuum limiting using leakage air added.

Order no. 47291

Ordering matrix

07

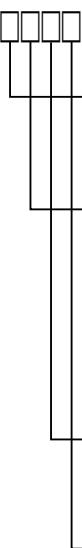

Vacuum Pumps

- 1 V-700 2 heads/2 stage (1.8 m³/h < 10 mbar)
- 2 V-710 4 heads/3 stage (3.1 m³/h 2 mbar)

Vacuum Controller/vacuum modules

- 0 Without vacuum controller
- 1 Simple vacuum control by needle valve
- 2 Vacuum Controller V-850 (Advanced)
- 3 Vacuum Controller V-855 (Professional)
- 4 Vacuum Module V-801 EasyVac
- 5 Vacuum Module V-802 LabVac

Woulff bottle

- 0 Without Woulff bottle
- 1 With Woulff bottle (recommended for vacuum systems with controller/module)

Secondary condenser

- 0 Without secondary condenser
- 1 Secondary condenser (including insulation)
- 2 Secondary cold trap

Vacuum Controller V-850



Individual device:

100–230 V, including power pack

Order no. 47231

Configuration for R-210/215

or V-700/710: 100–230 V, including holder and communication cable, without vacuum valve/valve unit.

Order no. 47299

Configuration for R-200/205:

100–230 V, including holder, communication cable and power pack, without vacuum valve/valve unit.

Order no. 47297

Configuration for R-220:

100–230 V, including holder and communication cable and power pack, without vacuum valve 31354.

Order no. 47295

Configuration for R-250:

100–230 V, including holder and communication cable and power pack, without vacuum valve 31355.

Order no. 47293

Vacuum Controller V-855



Individual device:

100–230 V, including power pack

Order no. 47232

Configuration for R-210/215

or V-700/710: 100–230 V, including holder and communication cable, without vacuum valve/valve unit.

Order no. 47298

Configuration for R-200/205:

100–230 V, including holder and communication cable and power pack, without vacuum valve/valve unit.

Order no. 47296

Configuration for R-220:



100–230 V, including holder and communication cable and power pack, without vacuum valve 31354.

Order no. 47294

Configuration for R-250:

100–230 V, including holder and communication cable and power pack, without vacuum valve 31355.

Order no. 47292

Vacuum Pumps	V-700	V-710
Capacity (DIN 28432)	1.8 m ³ /h *	3.1 m ³ /h **
No. of steps (heads)	2 (2)	3 (4)
Final vacuum (absolute)	<10 mbar	2 mbar
Final vacuum (with gas ballast)	24 mbar	8 mbar
Connections	GL 14	GL 14
Power consumption	210 W	370 W
Electrical requirements	100–240 V, 50–60 Hz	100–240 V, 50–60 Hz
Pump motor	DC, brushless	DC, brushless
Nom. speed	max. 1600 min ⁻¹	max. 1600 min ⁻¹
Sound pressure level (DIN 45635)	40–52 dB (A) depending on type of operation	41–55 dB (A) depending on type of operation
Safety class	IP 34	IP 34
Materials in contact with media	PEEK, PTFE, glass, FEP	PEEK, PTFE, glass, FEP
Weight	5.3 kg	10.4 kg
Approvals	CE 	CE 

* If the Eco²-mode is active (in case of unregulated operation without Buchi vacuum controller): after 0 h 1.8 m³/h, after 1 h 1.4 m³/h, after 2 h 1 m³/h

** If the Eco²-mode is active (in case of unregulated operation without Buchi vacuum controller): after 0 h 3.1 m³/h, after 1 h 2.4 m³/h, after 2 h 1.7 m³/h

Vacuum Controllers V-850/V-855 and Vacuum Modules V-801/V-802

Measurement range	1400–0 mbar (hPa), 1050-1 Torr
Control range	1100–1 mbar (hPa), 825-1 Torr
Measuring principle	capacitive, independent of gas type, absolute pressure gauge/sensor made from aluminium oxide-ceramic
Measuring accuracy	±2 mbar (±1 digit) – after proper calibration at constant temperature
Vacuum connection	GL 14
Temperature compensation	0.07 mbar K ⁻¹
Allowable ambient temperature	+10 °C to +40 °C
Power consumption	10 W
Connections	USB* (data transfer), RS232/RS485* (communication), remote control, cooling water valve,* switch box, vacuum valve
Power connections	30 VDC, from connection to Rotavapor R-210/215, Vacuum Pump V-700/710 or power pack 85–264 V
Weight	540 g
W x H x D	160 x 105 x 120 mm
Approvals	CE 

* Connections V-801/802

V-700

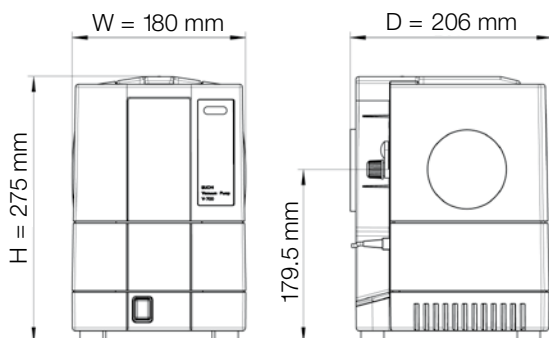

V-710

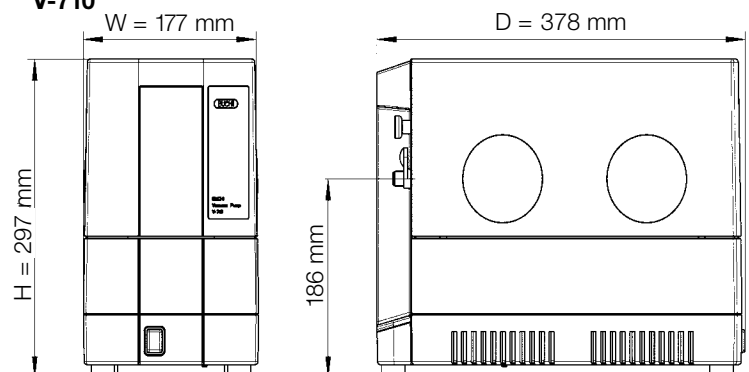

Spare parts

Replacement diaphragm

For V-700/710

Order no. 47153

Silicone hose

For cooling water, diameter 6/9 mm (per meter)

Order no. 04133

Vacuum hose, neoprene

(flexible)
Diameter 6/16 mm (per meter)

Order no. 17622

Vacuum hose, PTFE

(rigid)
Diameter 8/10 mm (per meter)

Order no. 27277

Control cable Mini-DIN 1500 mm

For use in combination with the previous generation of pumps and vacuum controllers for switching on and off of the pump

Order no. 38010

Control cable RJ45 2000 mm

Rotavapor and vacuum pump RJ45 2000 mm V-700/710, compatible with V-850/855

Order no. 44989

Communication and mounting kit

For Rotavapor R-210/215 and Vacuum Pump V-700/710 (including bracket and 2 communication cables)

Order no. 47280

Stage probe V-855

(only for glass assembly V+S)

Order no. 47235

BÜCHI Labortechnik AG
Postfach
9230 Flawil 1
Schweiz
T +41 71 394 63 63
F +41 71 394 65 65
buchi@buchi.com
www.buchi.com

BÜCHI Labortechnik GmbH
Postfach 10 03 51
45003 Essen
Deutschland
Freecall 0800 414 0 414
T +49 201 747 490
F +49 201 237 082
deutschland@buchi.com
www.buechigmbh.de

BÜCHI Labortechnik GmbH
Branch Office Netherlands
Postbus 142
3340 AC Hendrik-Ido-Ambacht
The Netherlands
T +31 78 684 94 29
F +31 78 684 94 30
netherlands@buchi.com
www.buchi.nl

BÜCHI Italia s.r.l.
Centro Direzionale, Milano Fiori
Pal. A-4, Strada 4
20090 Assago (MI)
Italia
T +39 02 824 50 11
F +39 02 57 51 28 55
italia@buchi.com
www.buchi.it

BUCHI (Thailand) Ltd.,
77/175, Sin Sathon Tower,
39th FL, Unit F
Krungthongburi Rd.
Klongtong, Klongsan
Bangkok 10600
Thailand
T +66 2 862 08 51
F +66 2 862 08 54
bacc@buchi.com
www.buchi.com

BUCHI India
Private Ltd.
201, Magnum Opus
Shantinagar Industrial Area
Vakola, Santacruz (East)
Mumbai 400 055,
India
www.buchi.com

BUCHI Corporation
19 Lukens Drive, Suite 400
New Castle
Delaware 19720
USA
T +1 302 652 3000
F +1 302 652 8777
Toll Free: +1 877 692 8244
us-sales@buchi.com
www.mybuchi.com

BUCHI Hong Kong Ltd.
1810 Fortress Tower
250 King's Road
North Point, Hong Kong
China
T +852 2389 2772
F +852 2389 2774
china@buchi.com
www.buchi.com

BUCHI Shanghai Trading LLC
21/F Shanghai Industrial
Investment Building
18 Caoxi Bei Road
200030 Shanghai
China
T +86 21 6468 1888
F +86 21 6428 3890
china@buchi.com
www.buchi.com

BUCHI UK Ltd
5 Whitegate Business Centre
Jardine Way
Chadderton
Oldham OL9 9QL
United Kingdom
T +44 161 633 1000
F +44 161 633 1007
uk@buchi.com
www.buchi.co.uk

BUCHI Sarl
5, rue du Pont des Halles
Z.A. du Delta
94656 Rungis Cedex
France
T +33 1 56 70 62 50
F +33 1 46 86 00 31
france@buchi.com
www.buchi.fr

Nihon BUCHI K.K.
3F IMON Bldg.,
2-7-17 Ikenohata, Taito-ku,
Tokyo 110-0008
Japan
T +81 3 3821 4777
F +81 3 3821 4555
nihon@buchi.com
www.nihon-buchi.jp

We are represented by more than 100 distribution partners worldwide. Find your local representative at

www.buchi.com

Quality in your hands